



Installation and Operating instructions

JUDO UV-disinfection unit JUV 60 - 140 G / GS

**Please issue to the owner/operator.
Read carefully before installation/start-up!
Subject to change without notice.**



Part No.: 1702140



Contents

1	Introduction	4
1.1	Pictograms and their meaning	4
1.2	Warranty	5
1.3	Operation of the unit.....	5
1.4	Duties of the owner/operator	5
2	Transport / Scope of supply / Storage	6
2.1	Consumables and accessories	7
2.2	Spare parts	7
3	Product information	8
3.1	Manufacturer and type	8
3.2	Models	8
3.3	Dimensions	9
3.4	Operating data	11
4	Description of the UV-disinfection unit.....	12
4.1	Function.....	12
4.2	Quality of incoming water supply	13
4.3	Function control for UV-lamps	13
4.4	Limit values.....	13
4.5	UV-chamber (reactor).....	13
5	Installation	14
5.1	Before installation.....	14
5.2	Installation	15
5.2.1	Installation example	16
5.3	Installation of the UV-chamber (reactor).....	17
5.3.1	Installation position.....	17
5.3.2	UV-chamber (reactor)	18
5.4	Installation of the quartz sleeves and UV-lamps	19
5.4.1	Installation of the UV-sensor (JUV 60 - 140 GS)	22
5.5	Installation of the control unit.....	23
5.6	Electrical connection	24
6	Commissioning	26
6.1	Before commissioning	26
6.2	Description of the control unit.....	27



6.2.1	Display and control keys.....	27
6.3	Operating mode display	28
6.4	Enter password	29
6.5	Fault indication.....	31
6.5.1	Reset operating hours counter for UV-lamps.....	32
6.5.2	Adjusting UV-irradiation intensity (JUV 60 - 140 GS)	33
7	Errors	34
8	Maintenance and inspection	35
8.1	Visual inspections	35
8.2	Cleaning (generally not required within deionised water)	37
8.3	Replacing UV-lamps.....	38
8.4	Disposal of UV-lamps and concentrated cleaning agent.....	38
9	Operation log	39



1 Introduction

Thank you for making JUDO your brand of choice. Please take note of, and follow this instruction manual so that you can enjoy your unit for a long time. This instruction manual contains all the information needed for the installation, operation and maintenance of the described unit.

We make every effort to ensure you are a satisfied customer and ask that you contact your local JUDO representative if you have any questions concerning water treatment, e.g. adding further features to your existing system. Please quote the data given on the name plate with all enquiries.

JUDO-Wasseraufbereitung GmbH

Hohreuschstraße 39-41

D-71364 Winnenden

Telephone: +49 (0)1805/692-111*

Fax: + 49 (0)1805/692-188*

E-mail: info@judo.eu

*14 Cent/min. out of the German landline

1.1 Pictograms and their meaning

The words **Warning**, **Caution** and **Note**, highlighted in bold with matching pictogram, have the following meaning:



Warning **Risk of injuries and accidents!**



Caution **Risk of malfunctions or damage to the unit!**



Note **A special feature exists!**



Eye shield **Wear protective goggles!**



1.2 Warranty

The warranty, as defined in our General Terms and Conditions of Sale and Delivery, only applies if

- The unit is used according to the explanations in this instruction manual.
- The unit has not been opened or improperly handled in some other way.
- The electronic has not been opened.
- Repairs have been carried out by authorised, qualified employees only.
- Original spare parts only are used for repairs.
- Protection devices are applied and are not manipulated.

1.3 Operation of the unit

The UV-disinfection unit described in this manual is engineered for disinfection within the framework of the application described herein, but not to produce or protect the quality of potable water in Germany or Austria. Therefore DVGW-certificated respectively ÖVGW-certificated UV-disinfection units are available. Reading this manual as well as keeping all safety regulations and notes contained in it, belong likewise to the intended use.



Warning

Other uses are deemed to be undue, non-intended uses and are not allowed. JUDO Wasseraufbereitung GmbH is not liable for any losses whatsoever resulting from these applications!

1.4 Duties of the owner/operator

The owner/operator of the system is responsible for the following:

- Instructing the operating personnel.
- Arranging regular maintenance.
- Execute regular cleaning procedures if necessary.



2 Transport / Scope of supply / Storage

Transport:

- Transport unit carefully, do not throw!
- Risk of breakage! Do not damage the fragile components (quartz sleeves, UV-lamps, UV-sensor)!

Scope of supply:

JUV 60 - 140 G	JUV 60 - 140 GS
<ul style="list-style-type: none"> - Stainless steel UV-chamber (reactor) - High efficiency UV-lamps - Removable quartz sleeves (fused quartz) - Wall holders for control unit - Double bit key for control unit - Control unit - Installation and Operating instructions 	<ul style="list-style-type: none"> - Stainless steel UV-chamber (reactor) - High efficiency UV-lamps - Removable quartz sleeves (fused quartz) - Installation wrench for UV-sensor - UV-sensor - Wall holders for control unit - Double bit key for control unit - Control unit - Installation and Operating instructions

- UV-measuring device with indication in per cent (JUV 60 - 140 GS).
- Digital operating hours counter for control unit and UV-lamps.
- Drain.
- 230 VAC relay contact for shut-off solenoid valve as well as potential-free relay contact for output signal alarm.



Note

**If the connecting cable 3G 1.5 mm² for power supply factory-provided connected to the control unit is connected via a grounding receptacle, a shock-proof plug provided by customer must be connected respectively the connecting cable must be connected to the power supply via terminals!
Please check the delivered items are complete with respect to your order and are intact!**

**The units are transported and delivered complete and fully assembled!
Transport damage must be reported within 24 hours otherwise, for insurance reasons, loss claims cannot be settled!**



Storage:



Caution

**Dry, cool storage location with non-aggressive atmosphere!
Allowable storage temperature: 4 °C to 40 °C!**

2.1 Consumables and accessories

Description	Order No.
Concentrated cleaning agent (38 per cent phosphoric acid) 2x1litre	8721216
Time controlled solenoid valve JEM-AT $\frac{3}{8}$ " 230VAC/50Hz	8351008
Temperature controlled solenoid valve JEM-ATE $\frac{3}{8}$ " 230VAC/50Hz	8351009
Shut-off solenoid valve JEM $\frac{3}{4}$ " 230VAC/50Hz	8735113
Shut-off solenoid valve JEM 1" 230VAC/50Hz	8735114
Shut-off solenoid valve JEM 1 $\frac{1}{4}$ " 230VAC/50Hz	8735115
Shut-off solenoid valve JEM 1 $\frac{1}{2}$ " 230VAC/50Hz	8735116
Shut-off solenoid valve JEM 2" 230VAC/50Hz	8735117

Tab. 1: consumables and accessories



Note

Consumables and accessories are not included in the scope of supply!

2.2 Spare parts

Description	Order No.
UV-sensor for JUV 60 - 140 GS	On request
Reserve UV-lamp 40 W for JUV 60 - 140 G / GS*	8351021
Quartz sleeve for JUV 60 - 140 G / GS**	8351018
O-ring 23x4 screw cap quartz sleeve**	1200384

Tab. 2: spare parts

* Consider number of UV-lamps (see chapter 3.4)!

** Required for each UV-lamp!



Note

Spare parts are not included in the scope of supply!



3 Product information

3.1 Manufacturer and type

Manufacturer:

JUDO-Wasseraufbereitung GmbH

Hohreuschstraße 39-41

D-71364 Winnenden

Telephone: 01805/692-111*

Fax: 01805/692-188*

E-mail: info@judo.eu

*14 Cent/min. out of the German landline

Type:

JUDO UV-disinfection units JUV 60 - 140 G / GS

3.2 Models

Model	Order No.	Model	Order No.
JUV 60 G	8350067	JUV 60 GS	8350075
JUV 80 G	8350069	JUV 80 GS	8350077
JUV 140 G	8350070	JUV 140 GS	8350078

Tab. 3: models



3.3 Dimensions

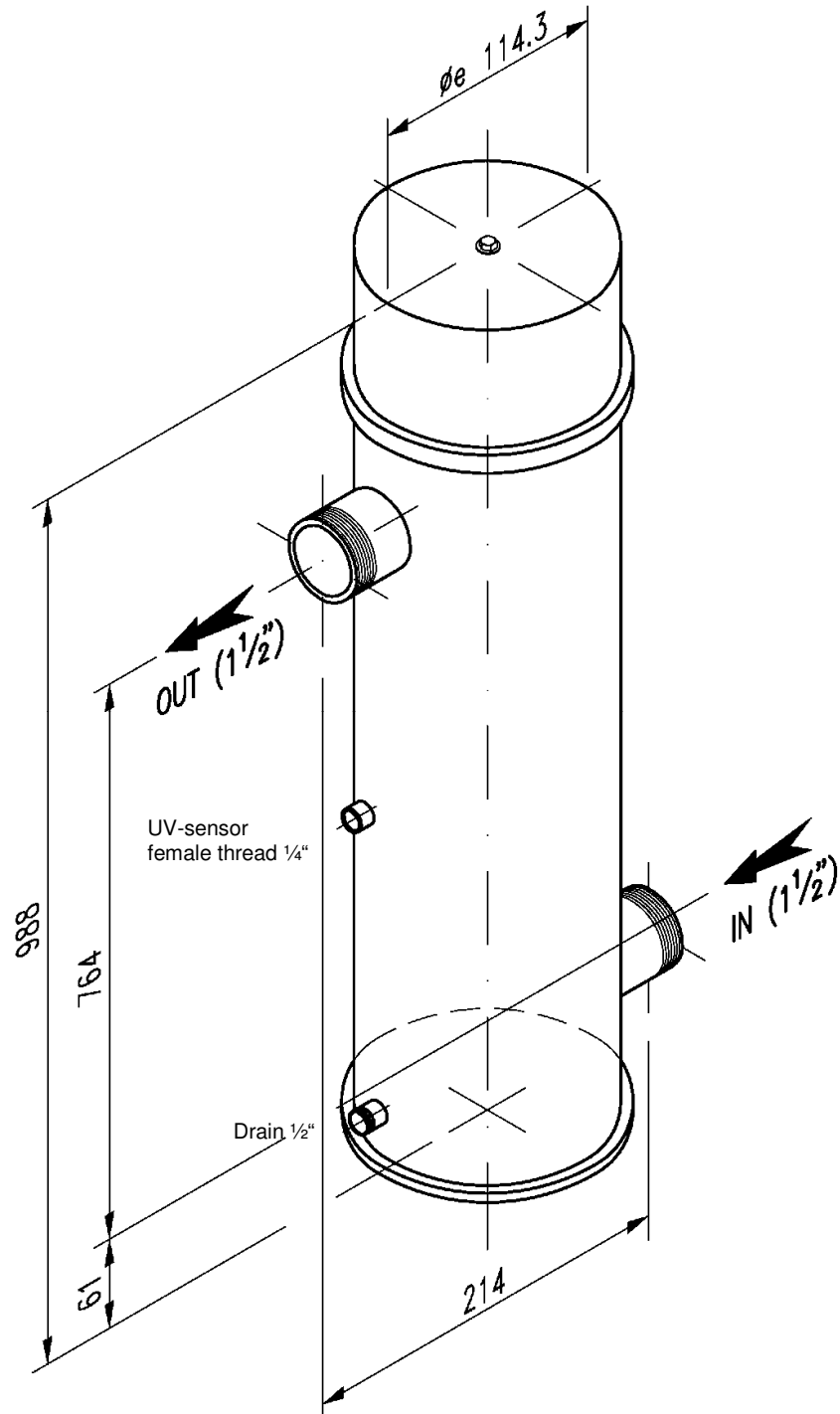

Fig. 1: JUV 60 - 80 G / GS [mm]

Date created: 21.09.09

Release date: 25.09.09

Operating instructions: JUDO UV-disinfection unit JUV 60 - 140 G / GS

Revision date: 12.10.09

Version: 1.000

Operating instructions: JUDO UV-disinfection unit JUV 60 - 140 G / GS

JUDO Wasseraufbereitung GmbH

P.O. Box 380 • D-71351 Winnenden

Tel. +49 (0)1805/692-111* • Fax +49 (0)1805/692-188*

E-Mail: info@judo.eu

* 14 Cent/min. out of the German landline

In the interests of engineering progress, subject to change without notice!

9-39

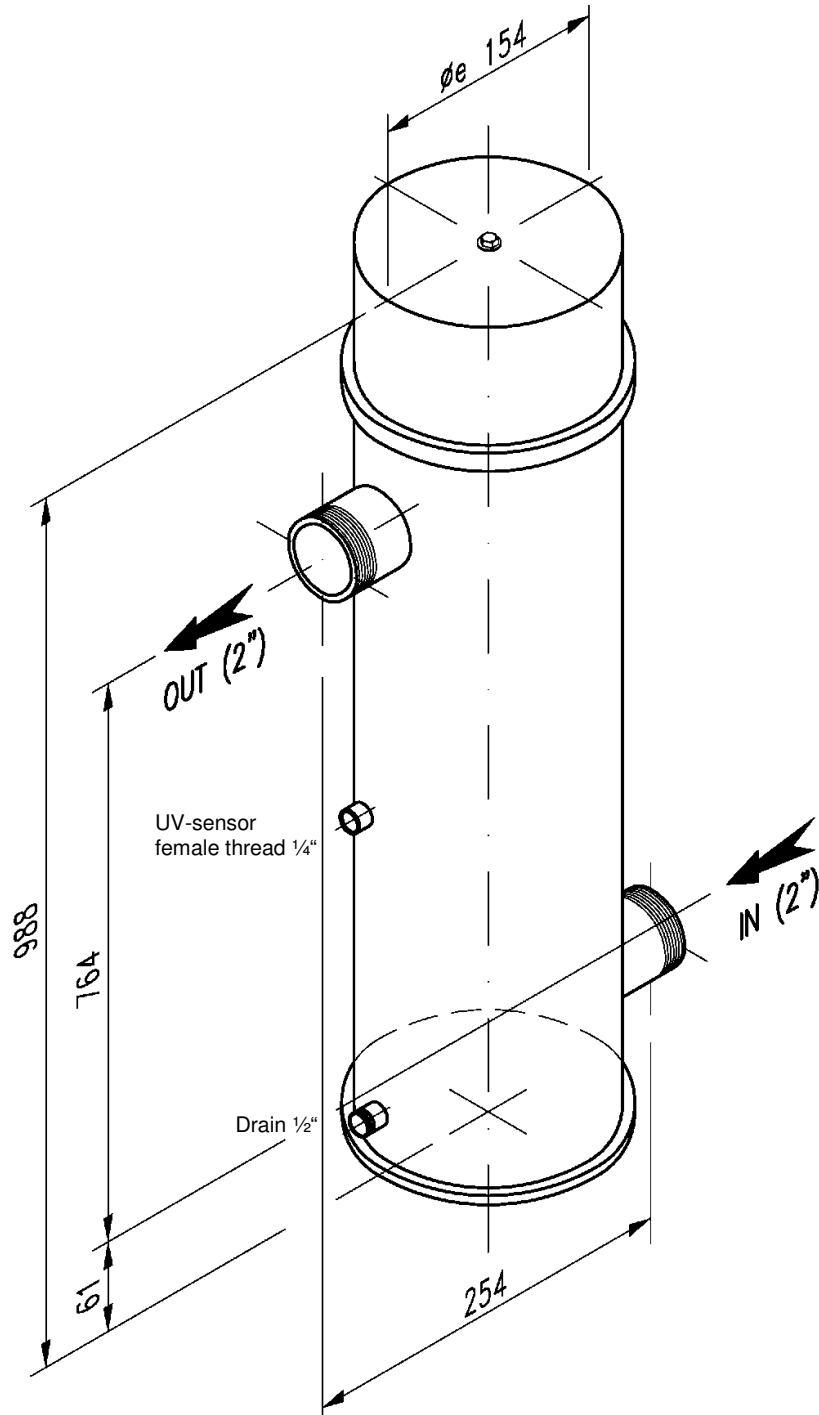

Fig. 2: JUV 140 G / GS [mm]



3.4 Operating data

Model JUV G / GS	60	80	140
Flow rate at 400 J/m ² UV-dose [m ³ /h]*	6.0	8.0	14.0
Flow rate at 300 J/m ² UV-dose [m ³ /h]*	8.0	10.6	18.6
Flow rate at 250 J/m ² UV-dose [m ³ /h]*	9.6	12.8	22.4
Max. permissible operating pressure [bar]	9	9	9
Operating temperature [°C]	4 - 40	4 - 40	4 - 40
Pipe connection male thread ["]	1½	1½	2
Deaeration female thread ["]	1/8	1/8	1/8
Drain valve female thread ["]	1/2	1/2	1/2
Power supply [VAC] ± 10 per cent	230	230	230
Frequency [Hz]	50/60	50/60	50/60
Electrical consumption [W]	85	130	175
Internal fuse power supply 5x20 mm [A]	3.15	3.15	3.15
Internal fuse of UV-lamps 5x20 mm [A]	3.15	3.15	3.15
Max. pre-fuse [A]	6	6	6
Total capacity UV-lamps [W]	80	120	160
Number of UV-lamps	2	3	4
Protection classification control unit	IP 55	IP 55	IP 55
Connection earthing UV-chamber male thread	M4	M4	M4
Weight UV-chamber (empty) [kg]	12.5	12.5	15
Dimensions control unit (WxHxD) [mm]	300x400x200	300x400x200	300x400x200
Weight control unit [kg]	13.0	13.0	13.0

Tab. 4: operating data

* Performance data bases on 15 °C, 96 per cent UV-transmission after 1cm water film thickness.

Differing flow rates, higher temperatures and differing water conditions result in variations (counselling of JUDO's technical advisers required).



4 Description of the UV-disinfection unit

Main items of the UV-disinfection unit are UV-chamber (reactor) with UV-lamps, quartz sleeves, UV-sensor (JUV 60 - 140 GS) and control unit. The unit is delivered ready for connection including connecting cable (without connecting plug).

4.1 Function

The disinfection of water by means of ultraviolet light (UV) is an efficient, economic and particularly environmentally friendly process.

UV-light kills pathogenic microorganisms without residues, injurious by-products or annoyance due to odour and taste within a few seconds. Thus exposure for the operating personnel by handling harmful chemicals is also excluded.

The effect of the UV-light is achieved by application of high efficient UVC-radiation with a wavelength of 254nm. This effects a photochemical reaction in the essential desoxyribonucleic acid (DNA) of the microorganisms within a few seconds. Thus the microorganism gets killed or its growth gets stopped.

The rate of reduction depends on the minimum UV-dose, thus the time, during a microorganism is subjected to a certain UV-irradiation intensity [W/m²].

To ensure safe disinfection of potable water the required reduction of the main human pathogenic bacteria, parasites and viruses by 4-log is obtained with an UV-dose of 400 J/m².

To ensure that each volume element of the water receives the required UV-dose, the irradiation field and the hydraulic features of the UV-chamber (reactor) are optimised to achieve highest performance.

The UV-irradiation causes no undesired side reactions by the applied UV-dose for disinfection. As no substance with disinfectant effect is added to the water by the UV-irradiation, no depot effect exists after passing the UV-chamber (reactor).



Caution

The disinfection capacity is only assured if original JUDO spare parts are used!



4.2 Quality of incoming water supply

The water to be treated must be clear, free of sediment content and of iron and manganese content. The UV-transmission should at least be 96 per cent after 1cm water film thickness and the water hardness should be less than 10° German hardness!

4.3 Function control for UV-lamps

UV-lamp failure and/or too low UV-irradiation intensity (JUV 60 - 140 GS) is immediately signalled by the electronic system. Main components are UV-sensor (JUV 60 - 140 GS), sensor electronics, LED "ALARM", text display, potential-free relay contact for malfunction as well as 230 VAC relay contact to switch external safety devices, e.g. shut-off solenoid valves.

The permanent measurement of the UV-irradiation intensity (JUV 60 - 140 GS) assures highest degree of operating safety. Any failure will be displayed without delay, via the potential-free contact malfunction can be signalled external (observe chapter 5.6).

4.4 Limit values

The required minimum dosage of UV-irradiation intensity is assured via the firmly factory-set limit value for alarm.

4.5 UV-chamber (reactor)

To ensure that each volume element of the water receives the required UV-dose, the irradiation field and the hydraulic features of the UV-chamber (reactor) are optimised to achieve highest performance.

In the cylindrical UV-chamber (reactor) the UV-lamps are centred axially and protected by the quartz sleeves. The UV-lamps as well as the quartz sleeves can be easily replaced by hand during maintenance works.

Due to the fact that the UV-lamps are totally encapsulated by the UV-chamber (reactor), escape of UV-light is absolutely impossible during normal operation. Thus there is no risk of UV-light exposure for the operator.

The flow must be interrupted and the UV-chamber (reactor) must be completely drained via shut-off valves provided by customer at the inlet and outlet of the UV-chamber (reactor) to clean respectively check the UV-sensor (JUV 60 - 140 GS).



5 Installation



Caution

In case of seepage on the water inlet or the unit itself, the water supply should be shut off when operating staff are not present!

5.1 Before installation



Caution

Do not spoil the breakable components (quartz sleeves, UV-lamps, UV-sensor) during installation!

- Assure before connecting the piping to the UV-chamber (reactor), that no impurities out of the piping (e.g. residual dirt of installation work) can get into the UV-chamber (reactor). For this it may be necessary to thoroughly rinse the whole reinstallation.
- Check that the whole reinstallation as well as the UV-chamber (reactor) is leak-tight at operating pressure and thoroughly deaerated.
- Assure the operational conditions on site (power supply, water condition, operational pressure, required space etc.) correspond with the technical data of the UV-disinfection unit.
- The UV-transmission and flow rate must not exceed the specified maximum values. Technical equipment for this purpose (flow transmitter, flow restrictor, measurement equipment for transmission etc.) is not included in the scope of supply.
- The UV-disinfection unit is designed for installation inside of a building. If the UV-disinfection unit will be installed outside of a building, adequate equipment must be installed to protect the UV-disinfection unit and the control unit against extreme weather conditions (e.g. rain, condensate, frost etc.)
- Check particularly the breakable components are intact.



5.2 Installation

- The UV-disinfection unit can be installed in horizontally or vertically running pipes (observe chapter 5.3.1).
- Flow direction from the bottom up (imperative at pressureless systems).
- To facilitate operation and maintenance, the unit should be installed at a point with ease to access.
- Operational data shown in this manual must be adhered to.
- The UV-disinfection unit should be installed free from distortion.
- If necessary additional installation equipment, e.g. brackets for the UV-chamber (reactor), is to be provided by customer.
- Assure that the UV-chamber (reactor) can be completely deaerated and drained.
- The water temperature can increase fast if the UV-lamps are switched on during no flow takes place in the UV-chamber (reactor). This is uncritical, as long as the water temperature does not exceed 40 °C and does not last longer than 30 minutes. To avoid critical situations it is recommended that applicable equipment and devices are considered already during installation work, e.g.
 - "dripping tap" or standpipe (> 0.5 m) in the outlet of the UV-chamber (reactor) or thermostat controlled valve to "squirt off" the warmed-up water.
 - fittings (shut-off valve, flow restrictor etc.) installed in such way, that heat accumulation is prevented.
- Do not install the control unit under leaking pipes.
- All rules, statutes and regulations governing installation and valid in the country of use must be observed and adhered to at all times.

Solutions to problems and other installation options can be clarified by JUDO's technical advisers.



5.2.1 Installation example

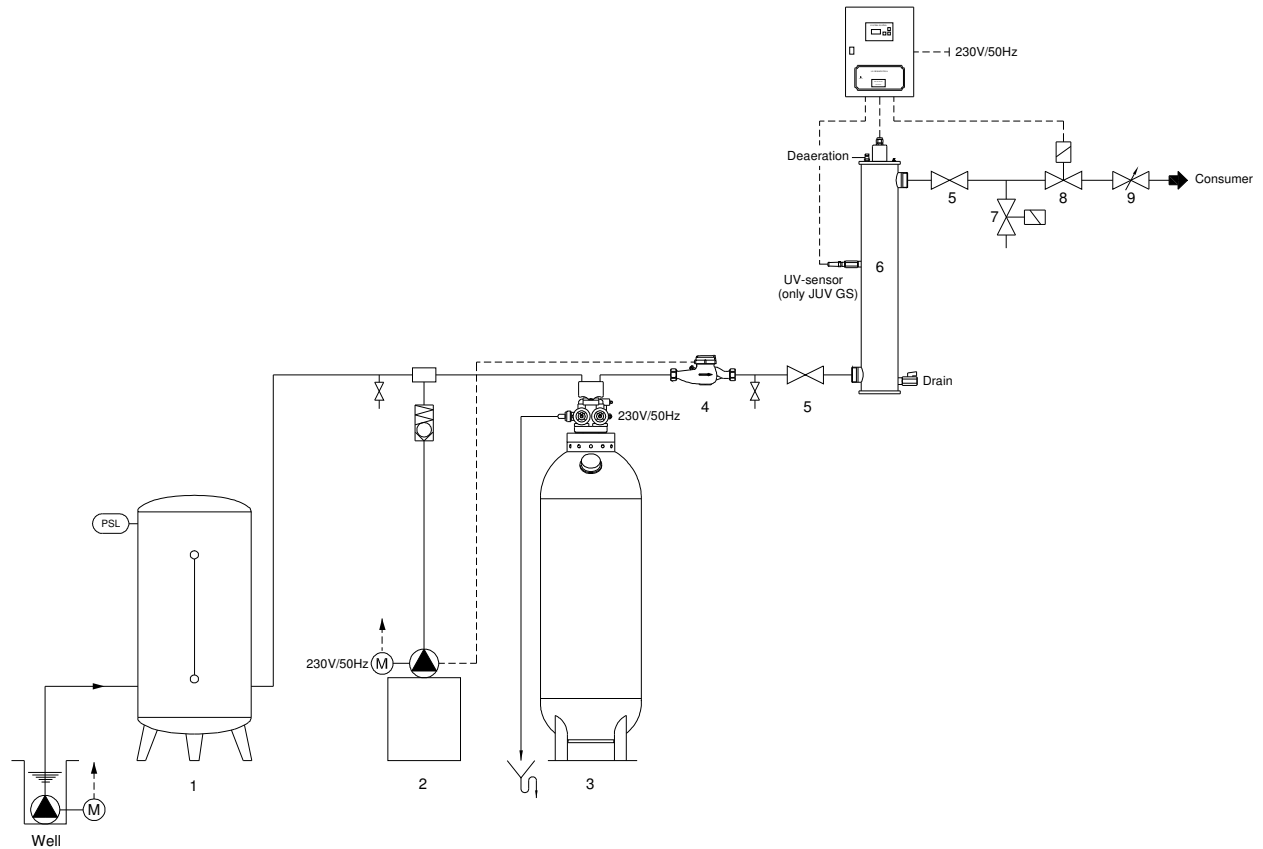

- 1 Pressurised storage tank (provided by customer)
- 2 JUDO Dosing pump unit JWD
- 3 JUDO E-series-filter JEF
- 4 JUDO contact water meter
- 5 Shut-off valve (provided by customer)
- 6 JUDO UV-disinfection unit JUV 60-140 G / GS
- 7 Optional: JUDO flushing valve time respectively temperature controlled
- 8 Optional: JUDO shut-off solenoid valve JEM 3/4"-2"/230V
- 9 Flow restrictor (provided by customer)

Fig. 3: installation example (here JUV 60 - 140 GS)



5.3 Installation of the UV-chamber (reactor)



Note

Prevent pressure surges to the UV-chamber (reactor), they could break the quartz sleeves respectively UV-lamps!

All piping as well as the UV-chamber (reactor) should be installed free from distortion, if necessary protect the UV-chamber (reactor) against freezing!

The UV-chamber (reactor) must be installed with additional equipment, e.g. brackets provided by customer!

5.3.1 Installation position

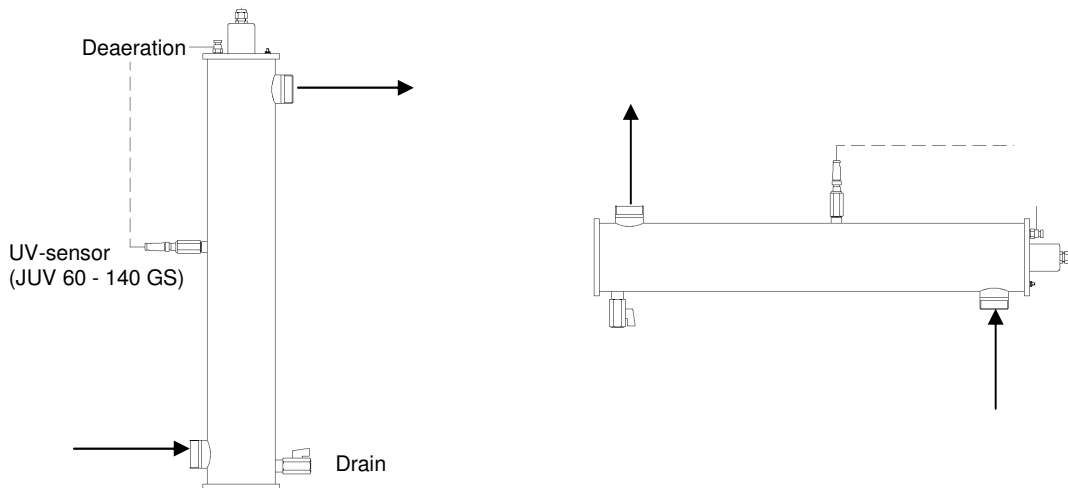

Fig. 4: installation position

The UV-chamber (reactor) must only be installed according to fig. 4.

To replace the UV-lamps and quartz sleeves during installation and maintenance work a space of at least 150 cm is required.



5.3.2 UV-chamber (reactor)

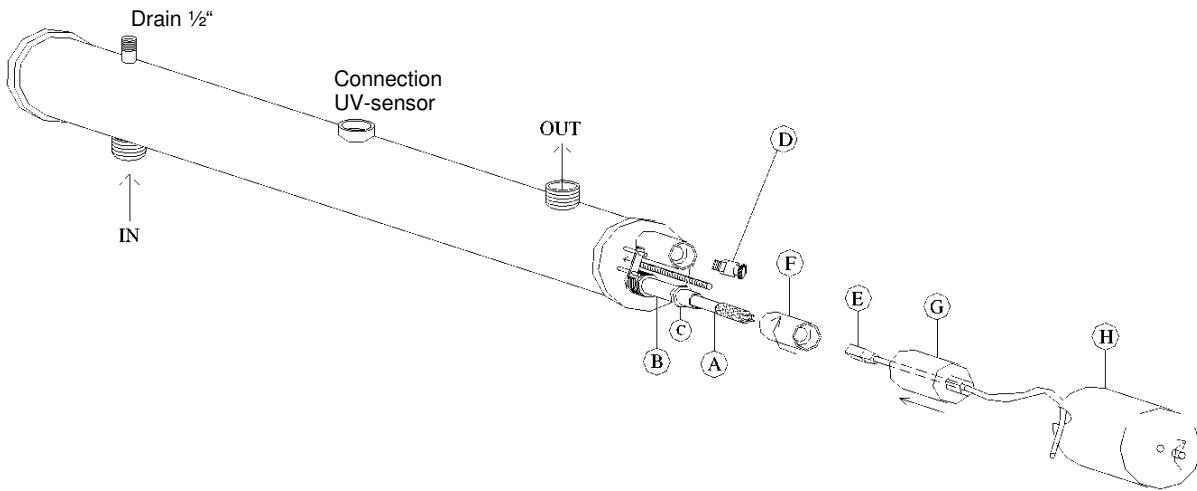

Fig. 5: components of the UV-chamber model JUV 60 G / GS

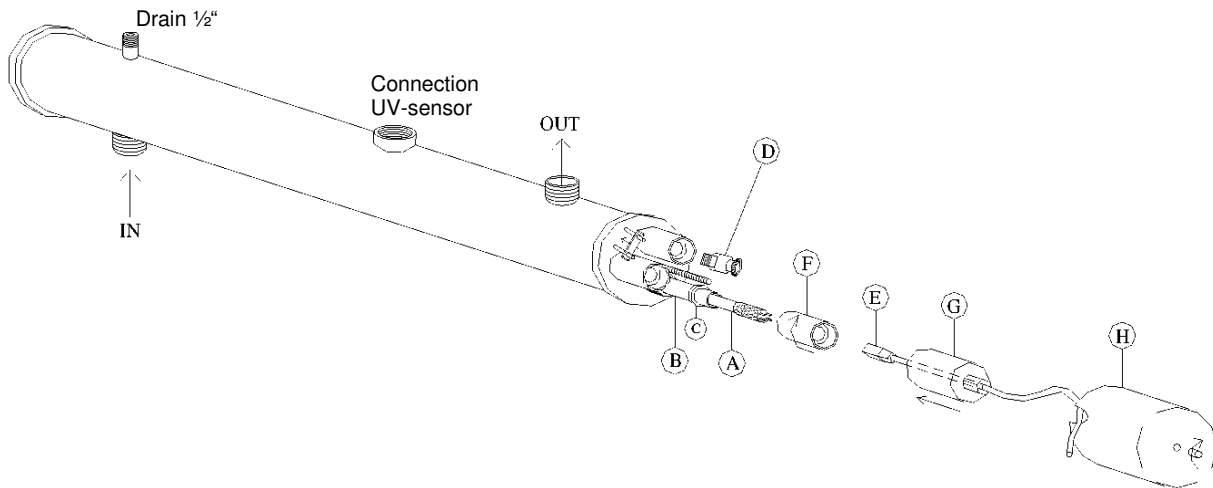

Fig. 6: components of the UV-chamber JUV 80 G / GS

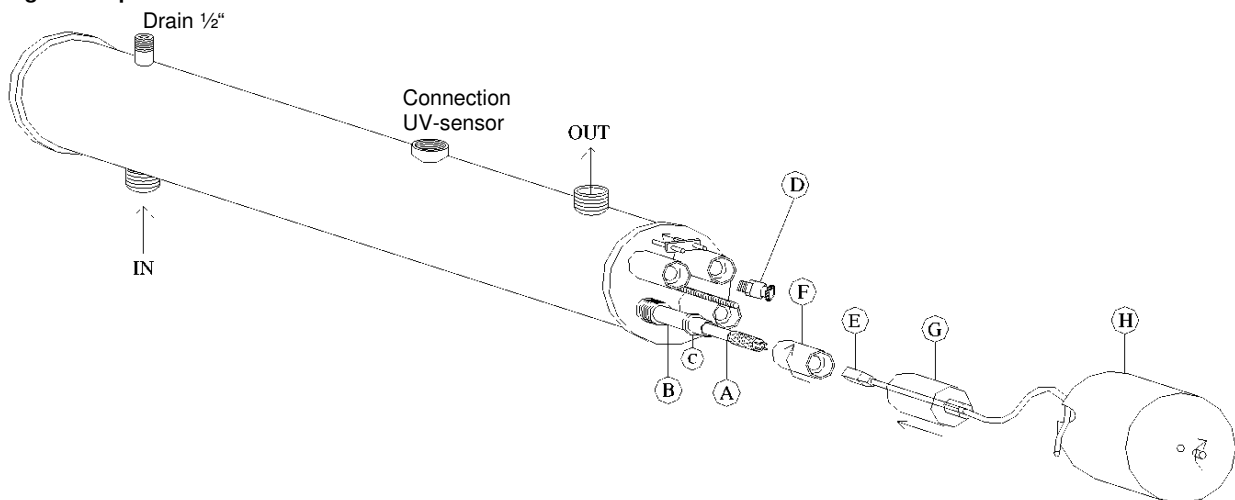

Fig. 7: components of the UV-chamber JUV 140 G / GS



Legend:

Pos.	Description	Pos.	Description
A	UV-lamp	F	Screw cap
B / C	Quartz sleeve / O-ring (23x4 mm)	G	Protective covering
D	Deaeration female thread 1/8"	H	Cover cap
E	Connecting plug for UV-lamps	IN / OUT	Inlet / Outlet

- The distance springs are not illustrated!

Tab. 5: components of the UV-chamber model JUV 60 - 140 G / GS

5.4 Installation of the quartz sleeves and UV-lamps



Caution

Prevent that the quartz sleeves and the UV-sensor are damaged, do not scratch them!

Clean the quartz sleeves and the sensor glass of the UV-sensor with a white, soft, clean and fibre-free cloth before installation, otherwise there is a risk of "burning-in" because of fingerprints (fat)!

The UV-lamps are designed for continuous operation and produce their highest disinfection capacity at this!

The durability of the UV-lamps can be considerably reduced when they are frequently switched ON and OFF!

The disinfection capacity is only assured if original JUDO spare parts (quartz sleeves, UV-lamps, UV-sensor) are used!

UV-C-radiation is harmful for eyes and skin, so the UV-lamps must only be operated when they are installed with the quartz sleeves in the UV-chamber (reactor) and all respective protective covering is installed!

Never subject persons to UV-C-radiation!



Eye shield

Wear protective goggles!

Depending on the model the UV-disinfection unit is equipped with several quartz sleeves and UV-lamps. The assembly of the quartz sleeves and the UV-lamps is carried out similarly with all models as consecutively described.

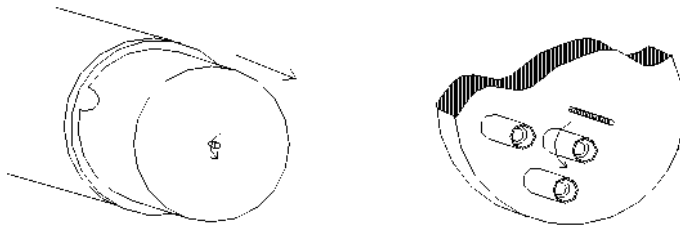

1. Unscrew the nut and take-off the cover cap. Afterwards, depending on the model of the UV-disinfection unit, unscrew all screw caps. Prevent that the O-rings between the threads of the UV-chamber (reactor) and the screw caps get lost.

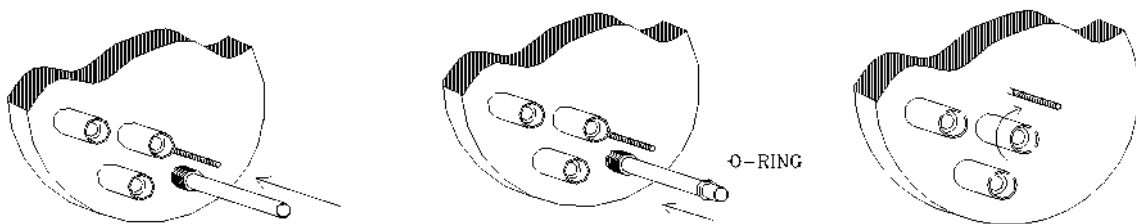

2. Insert the quartz sleeves carefully into the UV-chamber (reactor). Afterwards apply the O-rings over the quartz sleeves and adjust the screw caps in such way over the quartz sleeves, that the quartz sleeves contact the inner stop of the screw caps. Screw the caps by hand (max. 5 Nm) so that the O-rings tighten the connection.
3. Pressurise the UV-chamber (reactor) and assure all screw caps and all connections are tight, if necessary retighten the screw caps and connections.

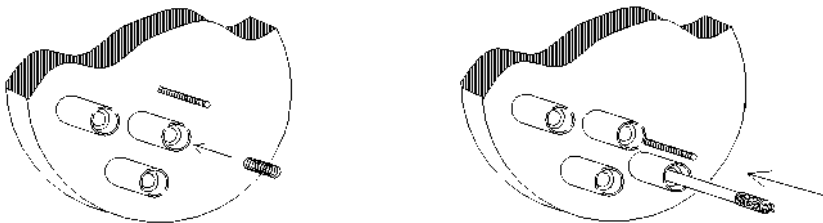

4. Insert the distance springs and afterwards the UV-lamps into the quartz sleeves.

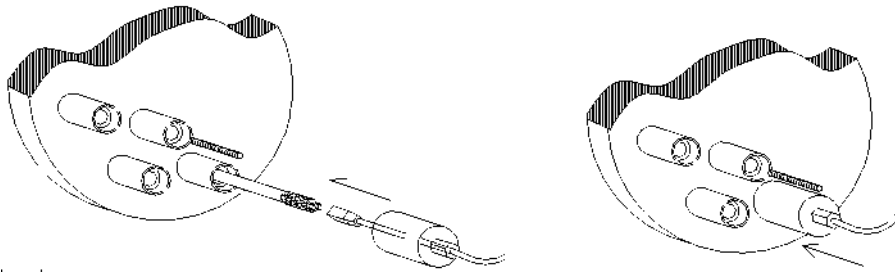

5. Connect the UV-lamps to the four corresponding pins of the connecting plugs. Position the protective covering (if necessary the position of the protective covering can be adjusted with the screwed cable glands).
6. Lead the connecting cables of the UV-lamps through the notch on the side of the cover cap and screw the cover cap with the nut.
7. Afterwards connect the protective earth conductor to the identified earthing connection of the UV-chamber (reactor).



5.4.1 Installation of the UV-sensor (JUV 60 - 140 GS)



Caution

Prevent that the UV-sensor is damaged, do not scratch it!

Clean the UV-sensor with a white, soft, clean and fibre-free cloth before installation!

Otherwise there is a risk of "burning-in" because of fingerprints (fat)!

The UV-sensor is factory-provided connected at the control unit and must only be screwed into the connection at the UV-chamber (reactor).

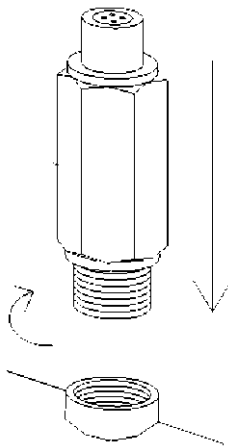

1. Loosen the threaded connection of the connecting plug at the UV-sensor and take-off the connecting plug.
2. Afterwards screw the UV-sensor with O-ring into the female thread 1/4" connection at the UV-chamber (reactor) and tighten it with the installation wrench (max. 5 Nm) included in the scope of supply.
3. Screw the connecting plug into the UV-sensor.

Fig. 8: installation of the UV-sensor

Cleaning the UV-sensor:



Note

Depending on the water conditions the UV-sensor must be cleaned at regular intervals!

Close therefore the shut-off valves provided by customer at the inlet and outlet of the UV-chamber (reactor)!

Put the UV-chamber (reactor) into pressureless condition and drain it completely, afterwards unscrew the dead UV-sensor out of the UV-chamber (reactor)!

Clean the sensor glass of the UV-sensor with a white, soft, clean and fibre-free cloth and the concentrated cleaning agent (observe chapter 8)!



5.5 Installation of the control unit



Caution

**Remove impurities out of the UV-chamber (reactor) before commissioning the control unit (otherwise there is a risk of “burning-in“)!
Avoid that the UV-chamber (reactor) runs dry respectively that the UV-disinfection unit is in operation for longer than 5 minutes without flow (overheating causes damage to the UV-lamps)!**

Install the control unit in a dry, frost-proof area with non-aggressive atmosphere which is not prone to explode. The power supply must be connected to the control unit according to all responsible regulations and standards valid in the country of use! Particularly the regulated safety instructions and standards valid in the country of use (e.g. residual current device) must be observed and adhered to at all times! A pre-fuse with a maximum of 6 Ampere is required. The UV-chamber (reactor) and control unit are delivered factory-provided ready for connection including connecting cable. If necessary connect a shock-proof plug provided by customer to the connecting cable.



Caution

**Manipulation to all connecting cables and the control unit is prohibited!
The protective earth conductor between the control unit and the UV-chamber (reactor) is imperative!**

The control unit can be installed individually on an even wall using the wall holders included in the scope of supply. The wall holders can be assembled vertically or horizontally at the control unit. Use therefore the Allen head screws, nuts and seals included in the scope of supply to assemble the wall holders at the back side of the control unit. Put the Allen head screws through the seals and insert them from inside through the fixing hole of the control unit. Mount the wall holders using the nuts and afterwards install the control unit on the wall.



5.6 Electrical connection



Caution

The electrical installation of the JUDO UV-disinfection unit may be accomplished exclusively considering of all responsible regulations and standards valid in the country of use by a licensed electrical specialist!

The control unit is not equipped with a mains switch, so a lockable mains switch respectively a circuit breaker to swith off the power supply and prevent reactivation during maintenances and repairs, as well as a residual current device (RCD) 25A/0,03A must be provided by customer and installed according to all responsible regulations and standards valid in the country of use!

The control unit is in operation respectively "STANDBY" once the power supply is switched on!

The specified protection classification of the control unit can only be ensured when the door of the control unit is locked with the double bit key, the wall holders are assembled with the seals and the screwed cable glands are hand-screwed!

The control unit is factory-provided supplied with a 1.5 meter connecting cable 3G 1.5 mm² for power supply. Connect the cable to the power supply protected by a lockable mains switch respectively circuit breaker. If necessary connect a shock-proof plug provided by customer to the connecting cable to supply the control unit via a grounding receptacle.

The electrical connection for the UV-lamps and the UV-sensor (JUV 60 - 140 GS) is also factory-provided ready for connection. A shut-off solenoid valve can be connected to the the relay contact (230 VAC / max. 2 Ampere) respectively an output signal for alarm can be tapped via the potential-free relay contact as described in the following:

1. Open the control unit using the double bit key.
2. Equip the free cable entries with screwed cable glands, lead the connecting cables for the shut-off solenoid valve respectively output signal for alarm through the screwed cable glands and connect them professionally according to the terminals (see fig. 9).
3. Screw the cable glands and lock the door of the control unit (avoid that the connecting cable to the display is sharply knicked or clamped in the door).

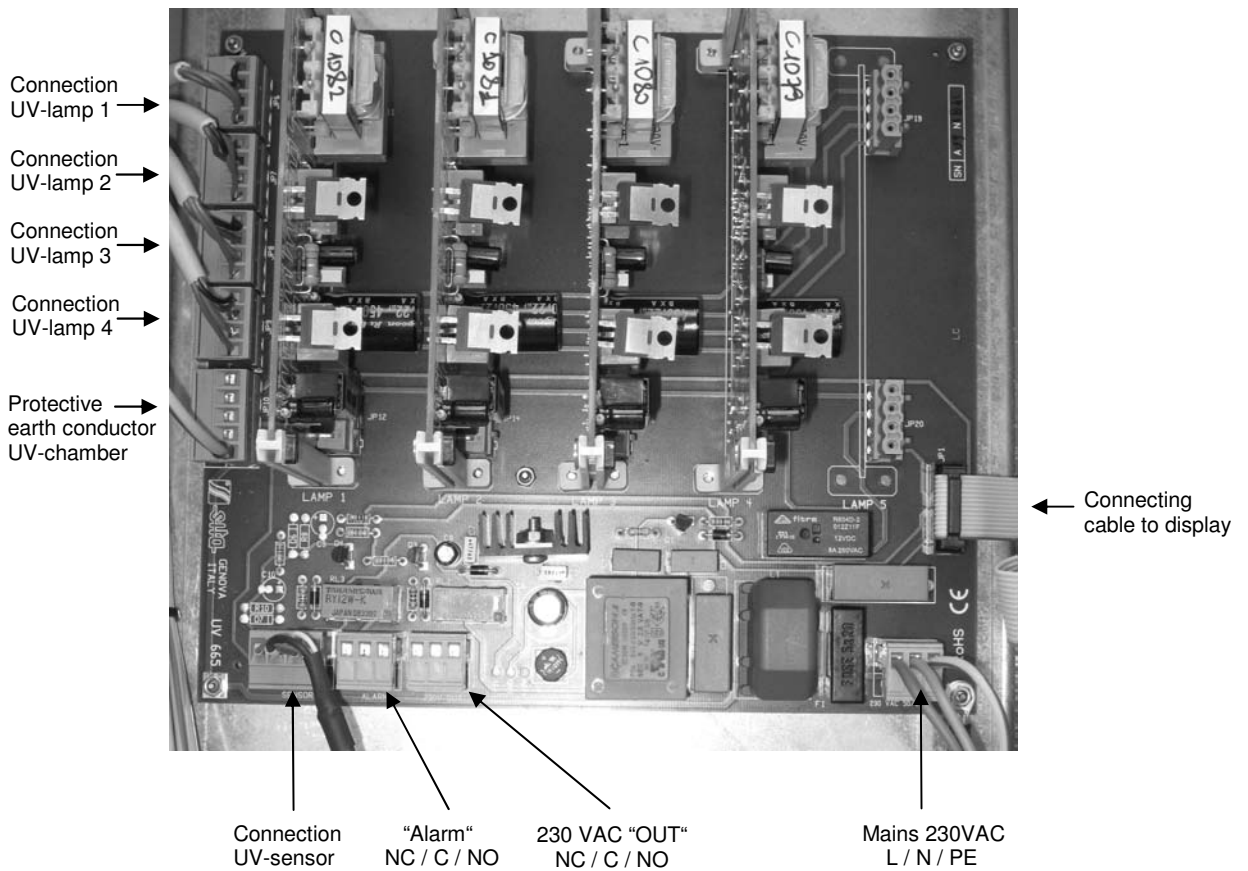

Fig. 9: electrical connection (here JUV 140 GS)

The control unit is designed for installation on a level wall and contains all required components for control, operation and monitoring. The red LED "ALARM", the display and the keys for operation are located in the door of the control unit.



6 Commissioning



Caution

Settings given for commissioning may need to be varied to meet with actual values on site!

Insufficient deaeration of the UV-chamber (reactor) and the piping can cause problems for the UV-control, furthermore e.g. pressure hammers could damage the quartz sleeves!

Under-run of the minimum flow rate causes overheating and damage to the UV-lamps!

During initial commissioning the water out of the UV-disinfection unit must be rejected for at least 10 minutes to drain!



Note

Commissioning should be carried out by persons with the correct qualifications only!

6.1 Before commissioning



Caution

When the UV-disinfection unit is in operation during the UV-chamber (reactor) is not filled with water or no flow takes place, this results in exceed temperature!

The operational data given in chapter 3.4 must be observed and adhered to at all times!

- Check before commissioning, that the reinstallation is leak-tight at operating pressure and thoroughly rinsed and that the UV-chamber (reactor) including piping is thoroughly deaerated.
- Afterwards document all setting in the operation log.



6.2 Description of the control unit

JUV 60 - 140 G:

The control unit is equipped with an LC-display, which indicates the operating hours, the theoretically residual durability of the UV-lamps and malfunctions. In the event of malfunction, the red LED "ALARM" flashes and the potential-free relay contact is activated. A shut-off solenoid valve can be connected to the 230 VAC relay contact to interrupt the flow. Via the keys for operation a password can be entered to protect the parameters against unauthorised access. Furthermore the UV-disinfection unit can be switched into "STANDBY" (ON / OFF) and a reset of the operating hours counter can be carried out after replacing the UV-lamps.





JUV 60 - 140 GS:

Such as model JUV 60 - 140 G, but with additional indication of the UV-irradiation intensity (per cent) as well as the temperature (°C). Furthermore the alarm for UV-irradiation intensity as well as the alarm for temperature protected by password can be entered via the control keys.

6.2.1 Display and control keys

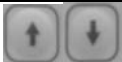

Fig. 10: display and control keys

Element	Description
	Red LED "ALARM" flashes in case of malfunction, simultaneously the potential-free relay contact "ALARM" and the 230 VAC relay contact for shut-off solenoid valve are acticated.
	Display for several parameters, operating hours counter and malfunctions.
	Key UP and DOWN to switch step by step to the several displays, enter the password and alter values of parameters.
	Key OK to switch the UV-disinfection unit On and OFF ("STANDBY") and to store altered values of parameters.



6.3 Operating mode display



When the UV-disinfection unit is switched OFF with key OK , "STAND BY" is displayed.



Press OK  (for approx. 2 seconds) to start the heating-up period of the UV-lamps. During the heating-up period (approx. 3 seconds) "WAIT" is displayed.



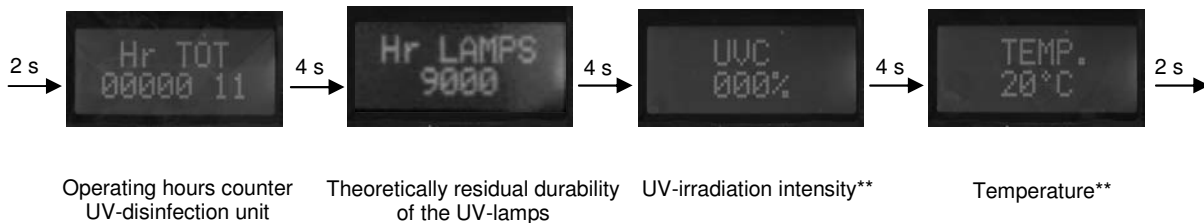

When the UV-lamps are heated-up the operating mode display alters in a time interval of about 4 seconds between the illustrated displays. The UV-disinfection unit is in operation.



Note

* **The actual serviceable life of the UV-lamps depends on the water quality and the operational conditions on site and can be considerably reduced!**

** **The UV-irradiation intensity as well as the temperature are only displayed with model JUV 60 - 140 GS!**

Based on the operating mode display press UP  respectively DOWN  to access the submenu. Press UP  respectively DOWN  to change between the submenus. Press OK  to access the respective submenu.





Note

The display "CAL UVC? OK" is only available with model JUV 60 - 140 GS!





6.4 Enter password



Based on the operating mode display press UP  respectively DOWN  to get into SETUP-mode of the control unit. Press OK  to acknowledge the display “SETUP ? OK“.



Via the password you can alter the value of the operation-hour counter for UV-lamps, of the parameter for “alarm temperature“, “alarm UV-irradiation intensity“ as well as the number of UV-lamps in the UV-disinfection unit.

Press UP  respectively DOWN  to enter the password, to change between the three digits press OK . The SETUP-mode will be left automatically when no key is pressed for 10 seconds. After the correct password is entered, the control unit enables the access to alter the parameters.







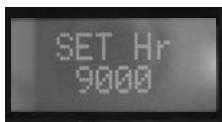

Note

These parameters must exclusively be altered by JUDO's customer service or authorised and qualified specialists!

Operating hours counter UV-lamps:









Press OK , the first digit position flashes. Then press UP  respectively DOWN  to alter the operating hours of the UV-lamps. To change between the four digits press OK .

A maximum value of 9.000 operating hours may be set. Press OK  to store the altered value. Afterwards press DOWN  to get to the next parameter.

Alarm temperature:







Press OK , the first digit position flashes. Then press UP  respectively DOWN  to alter the value for alarm of the temperature in the UV-chamber (reactor). To change between the two digits press OK .



A maximum value of 35 °C may be set. Press OK  to store the altered value. Afterwards press DOWN  to get to the next parameter.



Alarm UV-irradiation intensity:







Press OK , the first digit position flashes. Then press UP  respectively DOWN  to alter the value for alarm of the UV-irradiation intensity. To change between the two digits press OK .

The value of 50 per cent is factory-set. This value must be adjusted to the operational conditions on site. Press OK  to store the altered value. Afterwards press DOWN  to get to the next parameter.

Number of UV-lamps:



Press OK , the digit position flashes. To alter the number of UV-lamps installed in the UV-disinfection unit, press UP  respectively DOWN . Afterwards press OK  to store the altered value.

Press DOWN  to quit SETUP-mode.

Exit SETUP-mode:

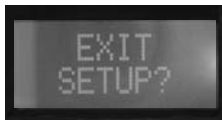

Press OK  to exit SETUP-mode and store all altered values.



6.5 Fault indication

UV-lamps:

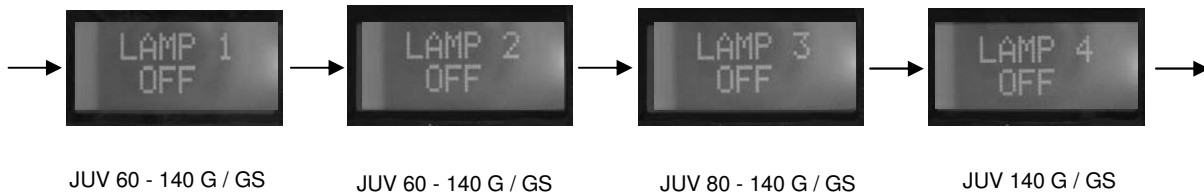

Malfunctions of UV-lamps are displayed with "LAMP X OFF". The display alters because of different numbers of UV-lamps in the UV-disinfection units. Check if UV-lamps are damaged respectively if fuses are burned and replace them if necessary.

Operating hours of UV-lamps:



When the durability of the UV-lamps is up (countdown of 9.000 operating hours), "CHANGE LAMPS" is displayed. Replace the UV-lamps and afterwards reset the operating hours counter.

UV-irradiation intensity (JUV 60 - 140 GS):





If the UV-irradiation intensity is too low, "LOW UVC %" is displayed. This could be caused by dirty quartz sleeves, used-up UV-lamps, water with too low UV-transmission or a dirty sensor glass of the UV-sensor.

Excess temperature (JUV 60 - 140 GS):



In the event of exceed temperature in the UV-chamber (reactor), caused by air in the UV-chamber or when the flow is too low or does not take place, "HIGH TEMPER." is displayed and the control unit switches off the UV-lamps. Remedy the cause!



Press DOWN  until "RES. ERR. TEMP? OK" is displayed. Afterwards press OK  to acknowledge the alarm and to restart the UV-disinfection unit.



Power failure:





In the event of power failure respectively burned fuses the display is off.

6.5.1 Reset operating hours counter for UV-lamps

After replacing the UV-lamps the operating hours counter for UV-lamps must be reset.



Based on the operating mode display press UP  respectively DOWN  to get to the corresponding mode. Press OK  to acknowledge the display "NEW LAMPS ?".



Press OK  again to acknowledge the display "NEW LAMPS OK". Now the operating-hour counter is reset.



After the operating hours counter is reset, the number of UV-lamp replacements is displayed, e.g. "CHANGE 003".



Note



After every replacement of the UV-lamps, the quartz sleeves as well as the UV-sensor (JUV 60 - 140 GS) must be cleaned (observe chapter 8)!

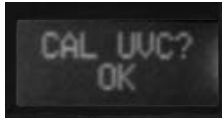

6.5.2 Adjusting UV-irradiation intensity (JUV 60 - 140 GS)

After the quartz sleeves and the UV-sensor are cleaned respectively after replacing the UV-lamps, the UV-irradiation intensity can be adjusted to 100 per cent.



Based on the operating mode display press UP  respectively DOWN  to get to the corresponding mode. Press OK  to acknowledge the display "CAL UVC ? OK".



The UV-irradiation intensity is displayed as a voltage value in mV. Press OK  to acknowledge the value.



Press OK  after the UV-irradiation intensity is adjusted. The voltage value is now equivalent to an UV-irradiation intensity of 100 per cent.



7 Errors



Warning

Switch off the power supply and prevent reactivation during maintenances and repairs at live components!

Fault	Cause
No display	Power supply not available.
	Burned fuse.
LED "ALARM" lights	Sensor cable disconnected respectively short-circuited.
	UV-sensor defective respectively without power supply.
	UV-lamps not installed respectively defective.
	UV-irradiation intensity under-run.
UV-lamp not working	Exceeded temperature in UV-chamber (reactor).
	Malfunction of UV-lamps.
	Faulty contact of the connecting cable, the connecting plug or the socket of UV-lamp.
	Ballast and/or ignitor respectively transformer defective.
	Power supply < 200 VAC.
UV-irradiation intensity too low	Water temperature < 5 °C.
	UV-transmission (<i>SSK-254</i>) of the water too low.
	Exceeded durability of UV-lamps.
	Cleaning of the UV-chamber (reactor) and the quartz sleeves is necessary.
Indicated UV-irradiation intensity "illogical"	UV-sensor dirty respectively defective.
	Bubbles in the water.
	Permanent variations of mains voltage and/or UV-transmission (water condition).
	External parastic induction to the sensor signal respectively the electronics (e.g. "aged" variable frequency driver or consumer load with non-sinusoidal current).

If the fault cannot be corrected using the information above please contact your local **JUDO customer service** or an authorised specialist company.

Customer service centre:

JUDO-Wasseraufbereitung GmbH

Hohreuschstraße 39-41

D-71364 Winnenden

Telephone: +49 (0)1805/692-111*

Fax: + 49 (0)1805/692-188*

*14 Cent/min. out of the German landline

Stamp of installation firm



8 Maintenance and inspection

In most countries, regular inspection and maintenance of units used in water treatment is required. We recommend this maintenance be carried out every 6 months or, at the latest, every 12 months. Signing a maintenance contract with your local service agent will ensure this maintenance is done without you having to remember it.

8.1 Visual inspections

Daily check the LED and the display for operability. The function of the UV-disinfection unit can be already restricted when alarm is displayed and the red LED lights. Then the quartz sleeves and the UV-sensor (JUV 60 - 140 GS) must be controlled for scale as soon as possible and if necessary cleaned.

The low UV-irradiation intensity can also be caused by “aged“ UV-lamps or “bad“ water quality. Visual inspections in quaterly intervals give information about required cleaning work. Cleaning intervals can only be scheduled resulting from the experience of visual controls to adapt them to the given operating conditions on site.

Inspection and cleaning of the UV-sensor (JUV 60 - 140 GS):

- Slowly close the shut-off valves at the inlet of the UV-chamber (reactor), afterwards at the outlet.
- Switch off the control unit, put the UV-chamber (reactor) into pressureless condition and drain it completely.
- Disconnect the connecting cable at the UV-sensor (observe chapter 5.4.1).
- Use the installation wrench included in the scope of supply to unscrew the UV-sensor out of the UV-chamber (reactor).
- Clean the sensor glass of the UV-sensor with a white, soft, clean and fibre-free cloth. Only hand-screw the UV-sensor (if necessary retighten the UV-sensor ~ 10 ° using the installation wrench). Never remove the sensor glass out of the UV-sensor!
- Afterwards deaerate the UV-chamber (reactor), commission the UV-disinfection unit again and document the result in the operation log!



Inspection of the quartz sleeves and UV-lamps:

No special tools are necessary for assembly and disassembly.

- Slowly close the shut-off valves at the inlet of the UV-chamber (reactor), afterwards at the outlet.
- Switch off the control unit, put the UV-chamber (reactor) into pressureless condition and drain it completely.
- Remove the quartz sleeves and the UV-lamps carefully (observe chapter 5.4).
- Clean the quartz sleeves with a white, soft, clean and fibre-free cloth.
- Insert the quartz sleeves carefully into the UV-chamber (reactor) and check that the O-rings are positioned correctly and are intact.
- Pressurise the UV-chamber (reactor) and assure all screw caps and all connections are tight, if necessary retighten the screw caps and connections.
- Afterwards deaerate the UV-chamber (reactor), commission the UV-disinfection unit again and document the result in the operation log!



Caution

Use pure alcohol to clean fingerprints on the quartz sleeves before installation!



8.2 Cleaning (generally not required within deionised water)

Due to hardness scaling cleaning is already recommended when the UV-irradiation intensity decreased of ~ 20 per cent after commissioning respectively last cleaning procedure. Cleaning the quartz sleeves is necessary at the latest when "LOW UVC %" is displayed (JUV 60 - 140 GS).



Note

Always clean the quartz sleeves and the UV-sensor at the same time to remove hardness scaling and impurities by means of applicable cleaning agents!

For cleaning we recommend the concentrated cleaning agent (see chapter 2.1) to remove particularly minerally deposits of dissolved solids (e.g. calcium carbonate)!

Generally the cleaning agent is used as concentrate, to prepare a dilution (with water) at least 20 per cent of the concentrated cleaning agent is required!



Warning

Observe the safety data sheets of the concentrated cleaning agent!

Protect eyes, hands and clothes when handling with concentrated cleaning agent, immediately wash off splashes with water!

All rules, statutes and regulations governing accident prevention and valid in the country of use must be observed and adhered to at all times!

The room must be thoroughly aired during reaction time of the cleaning agent, smoking and open flames are prohibited!



Caution

Do not operate the UV-disinfection unit while the shut-off valves are closed, otherwise there is a risk of overpressure!



8.3 Replacing UV-lamps

The higher the available UV-irradiation intensity, the better the effectivity of the UV-disinfection unit. The UV-irradiation intensity decreases permanently caused by ageing of the UV-lamps. Resulting from the specified operational parameters replacement of the UV-lamps is required, when in spite of previous cleaning alarm is signalled anymore. Generally replacement is required after 9.000 operating hours, but can be reduced depending on the water quality and the operational conditions. If the required water quality is not obtained with the available UV-irradiation intensity, earlier replacement will be necessary. Particularly when treating water with changing UV-transmission assure that appropriate reserve of UV-irradiation intensity is available. In the event of turbidity (suspended solids in the water) enhanced pre-treatment (filtration) is required.



Warning

Do not operate the UV-lamps outside the UV-chamber (reactor)!
Extended exposure to UV-light causes redness respectively burn to the skin (strong sunburn)!
UV-lamps can get hot!



Eye shield

Wear protective goggles!



Caution

Only hold the UV-lamps vertically at the socket and the ending when they are installed or replaced, otherwise there is a risk of breakage to the socket!
Do not touch the glass of the UV-lamps, otherwise there is a risk of "burning-in" because of fingerprints (fat)!
Use pure alcohol to clean fingerprints on the glass of the UV-lamps before installation!
Immediately replace a damaged quartz sleeve, otherwise there is a risk of breakage (leakage)!
Observe chapter 5.4!

8.4 Disposal of UV-lamps and concentrated cleaning agent

UV-lamps must be disposed of in the same way as conventional fluorescent lamps. They contain small quantities of mercury (amalgam) and must consequently be returned unbroken to the respective collective depot.

Delute used-up concentrated cleaning agent with a lot of water and neutralise it with e.g. caustic soda or lime stone. Observe regulations governing disposal and valid in the country of use.



9 Operation log



Note

Please log all required data carefully!

General data:						
Building project:						
Street:						
Postcode:			City:			
Contact person:						
Telephone:			Fax:			
Proxy person:						
Telephone:			Fax:			
	JUV 60 G		JUV 80 G		JUV 140 G	Device No.
	JUV 60 GS		JUV 80 GS		JUV 140 GS	Device No.
Date:						
Name:						
Indivated UV-irradiation intensity:						
Flow rate [m ³ /h]:						
UV-transmission after 10 mm:						
Operating hours of control unit:						
Operating hours UV-lamps:						
Duration of unit shutdown:						
Malfunctions:						
Malfunctions and damage of components:						
Replacing UV-lamps, cleaning and maintenance works:						
Other faults and their remedy:						
Sampling:						
Signature customer service						
Signature operator						